



INSTALLATION INSTRUCTIONS AND OWNER'S MANUAL

INSTALLER:

Leave this manual with the appliance.

CONSUMER:

Retain this manual for future reference.

⚠ WARNING

FIRE OR EXPLOSION HAZARD

If the information in this manual is not followed exactly, a fire or explosion may result causing property damage, personal injury or loss of life.

- Do not store or use gasoline or other flammable vapors and liquids in the vicinity of this or any other appliance.
- **WHAT TO DO IF YOU SMELL GAS**
 - Do not try to light any appliance.
 - Do not touch any electrical switch; do not use any phone in your building.
 - Leave the building immediately.
 - Immediately call your gas supplier from a neighbor's phone. Follow the gas supplier's instructions.
 - If you cannot reach your gas supplier, call the fire department.
- Installation and service must be performed by a qualified installer, service agency or the gas supplier.

IMPORTANT! Read these instructions carefully before installing or operating this gas appliance. These instructions should be left with the homeowner for future reference.

RADIANT VENTED BURNER

REQUIRES VENTED LOG SET
FOR INSTALLATION IN
SOLID-FUEL BURNING FIREPLACES

HI/LOW
REMOTE MODELS  GAS-FIRED
BFR(2124,30)RN LISTED

⚠ DANGER

If not installed, operated and maintained in accordance with the manufacturer's instructions, this product could expose you to substances in fuel or from fuel combustion which can cause death or serious illness.

CONGRATULATIONS on the purchase of your new GAS BURNER! Your Decorative Gas Burner is designed and intended for installation in an approved, existing, fully vented, wood-burning fireplace, with a gas hook-up.

This appliance must be installed only in a solid-fuel burning fireplace with a working flue and construction of noncombustible materials.

This unit is **NOT** for use with solid fuel. Solid fuels shall **NOT** be burned in a fireplace where a decorative appliance is installed.

The vent damper must have a damper clamp attached to it to keep the damper from accidentally closing during operation.

TABLE OF CONTENTS

SECTION	PAGE
Before You Start.....	3
Carton Contents And Hardware Pack.....	4
Important Safety Information	5 - 6
Safety Information For Users of Propane Gas.....	7
General Information	8
Product Specifications	9
Introduction	10
Fireplace Preparation	10
Gas Supply	11 - 12
Installation.....	13 - 14
Door Operation	15
Hi/Low Lighting Instructions.....	16
Pilot And Main Burner Flame Characteristics	17
Hi/Low (BFR) Wiring	18
Remote Operation	19 - 21
Maintenance And Service	22
Troubleshooting	23
BFR Parts List And Exploded View.....	24
Master Parts Distributor List	25
How To Order Repair Parts.....	25
Warranty	26
Appliance Service History.....	27

BEFORE YOU START

Samples and Definitions:

DANGER

Indicates a hazardous situation which, if not avoided, will result in death or serious injury.

WARNING

Indicates a hazardous situation which, if not avoided, could result in death or serious injury.

CAUTION

Indicates a hazardous situation which, if not avoided, could result in minor or moderate injury.

NOTICE: Addresses practices not related to personal injury.

1. Read the safety information on pages 5 - 7.
2. Review gas line information on pages 11 and 12.
3. Review the wiring information on page 18.
4. Light the burner and troubleshoot. See pages 16 and 21.
5. Show the homeowner how to operate the burner.
6. Show the homeowner how to do the basic maintenance.

These instructions are intended as a general guide and do not supersede national or local codes in any way. Authorities having jurisdiction should be consulted before installation.

- Follow all local codes regarding installation, combustion and ventilation air or in the absence of local codes follow the National Fuel Gas Code ANSI Z223.1(U.S. installation), or CAN/CGA-B149, Installation Code (Canada installation) and with ANSI Z21.60 Decorative Vented Appliances for Solid Fuel Burning Fireplaces.
- Installation and provision for combustion and ventilation air must conform to the *National Fuel Gas Code, ANSI Z223.1*, or *CAN/CGA-B149.1, Natural Gas Installation Code*, or *CAN/CGA-B149.2, Propane Installation Code*.
- The installation of appliances designed for manufactured home (U.S. only) or mobile home installation must conform with the *Standard for Mobile House, CAN/CSA Z240 MH*, in Canada, or with the *Manufactured Home Constructions and Safety Standard, Title 24 CFR, Part 3280*, in the United States, or when such a standard is not applicable, *Manufactured Home Installations Standard, ANSI/NCSBCS A225.1/NFPA 501A*.

CARTON CONTENTS & HARDWARE PACK

HARDWARE PACK CONTENTS

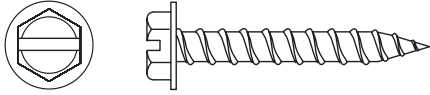

1/4" X 1 1/4" SLOTTED HEX HEAD ANCHOR SCREW (2)

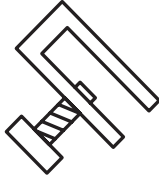

DAMPER CLAMP (1)

Items not shown to scale.

CARTON CONTENTS

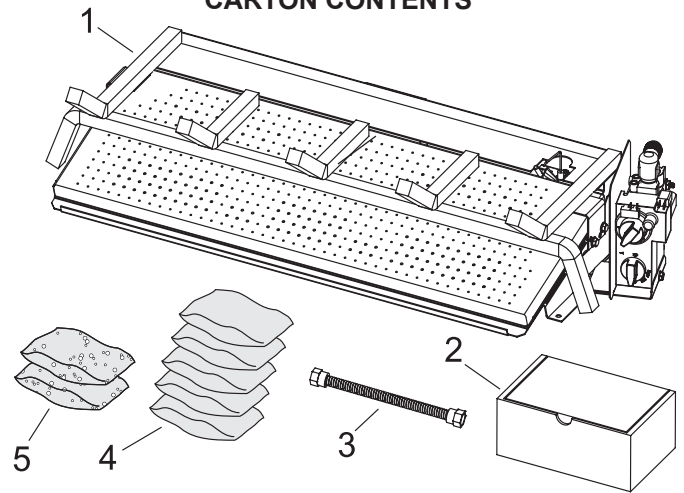

BFR(2124,30)RN			
INDEX NO.	DESCRIPTION	QUANTITY SUPPLIED	
		BFR2124	BFR30
1	Burner Assembly	1	1
2	Remote And Receiver Kit	1	1
3	Flexline	1	1
4	Rockwool Mix	5	5
5	Lava Rock	2	2
NS	Fiber Heat Sink	1	1

See Parts Lists on page 22 for ordering replacement parts. Do not order batteries, bolts, screws, washers or nuts. They are standard hardware items and can be purchased at any local hardware store.

IMPORTANT SAFETY INFORMATION

Installer: Leave these instructions with the owner. For Installation In Solid Fuel Burning Fireplaces. Do not burn wood or solid fuels in a fireplace where a decorative gas log set is installed. This appliance is for installation only in a solid fuel burning fireplace, masonry fireplace or manufactured fireplace.

WARNING

Before installing in a solid fuel burning fireplace, the chimney flue and firebox must be cleaned of soot, creosote, ashes and loose paint by a qualified chimney cleaner.

WARNING

Do not allow fans to blow directly into or at the fireplace. Avoid any drafts that alter burner flame patterns.

WARNING

Do not use a blower insert, heat exchanger insert or other accessory not approved for use with this appliance.

DANGER

Any modification to this gas log set or to controls can be dangerous. Improper installation or use of the gas log set can cause serious injury or death from fire, burns, explosion or carbon monoxide poisoning.

WARNING

Do not operate this burner with glass doors closed.

- Installation and repair must be done by a QUALIFIED SERVICE PERSON. The appliance should be inspected before use and at least annually by a qualified service person. More frequent cleaning may be required due to excessive lint from carpeting, bedding materials, etc. It is imperative that control compartments, burners and circulating air passageways of the appliance be kept clean.
- Do not place clothing or other flammable material on or near the appliance.
- Do not place trash or other articles on the log set during operation.
- Do not put anything around the fireplace that will obstruct the flow of ventilation air.
- Do not use this appliance if any part has been under water. Immediately call a qualified service technician to inspect the appliance and to replace any part of the control system and any gas control which has been under water.
- Do not use thermostats on vented burner applications
- Keep the appliance area clear and free from combustible material, gasoline and other flammable vapors and liquids.
- Keep burner and control compartment clean.
- A yearly examination and cleaning of the venting system of the solid-fuel burning fireplace must be performed by a qualified agency.
- Make a periodic visual check of pilot and burners. Clean and replace damaged parts.
- Alert children and adults to the hazards of high surface temperatures and caution them to stay away to avoid burns or clothing ignition.

- Carefully supervise young children when they are in the same room as the appliance.
- During manufacture, this burner is treated with certain oils, films and bonding agents. These substances are not harmful but may produce smoke and odors as they burn off during initial operation of the fireplace. This is normal. Open a window during the initial bake out period.
- Proper installation, burner pan location and log placement is important to achieve optimum look and performance of your gas log set. Follow the log assembly sequence for proper operation.
- Do not operate this log set with glass doors in the closed position. A fireplace screen must be in place when the log set is burning. Adequate combustion air must be provided for proper venting. All flames should go up and out the top of the firebox into the flue vent. If any flames float or curl forward into the room do not operate appliance. Check for an open flue and adequate combustion air into the room. A damper clamp must be installed on the firebox damper to maintain an open flue. See page 10.
- Young children must be carefully supervised when they are in the same room as the gas log while in operation. Do not place stockings, clothing or any flammable material above or near the fireplace.
- Do not substitute or use materials other than those supplied for use with the log set.

WARNING

Follow all gas leak check procedures in this manual, prior to operation.

WARNING

Fuels used in gas or oil-fired appliances, and the products of combustion of such fuels, contain chemicals known to the State of California to cause cancer, birth defects, and/or other reproductive harm. This warning is issued pursuant to California Health & Safety Code Sec. 25249.6.

DO NOT ATTEMPT TO DISCONNECT THE GAS OR ANY GAS FITTING WHILE THIS APPLIANCE IS IN OPERATION.

NEVER leave the decorative gas log set unattended while in operation.

NEVER allow children to operate this decorative gas log set.

NEVER place hands or fingers on the front-edge of this decorative gas log set.

NEVER use liquid propane gas in a natural gas unit, or natural gas in a liquid propane unit.

DO NOT use solid-fuel or lighter fluid in any decorative gas log set.

Any safety screen or guard removed for servicing an appliance must be replaced prior to operating the appliance.

IMPORTANT SAFETY INFORMATION (CONT'D)

WARNING

Do not use this appliance if any part has been under water. Immediately call a qualified service technician to inspect the appliance and replace any part of the control system and any gas control that has been under water.

All units with gas control valves must be lit by a Safety Pilot. The pilot is located at the right, rear of the unit. Follow these instructions exactly when lighting the appliance. BEFORE LIGHTING, smell around the appliance area for gas. Be sure to smell next to the floor, as propane gas is heavier than air and will settle to the floor. Use only your hand to rotate the gas control knob. Never use tools. If the knob will not turn by hand, do not try to repair it; call a qualified service technician or installer. Force or attempted repair may result in a fire or explosion.

WARNING

All gas burning appliances produce smoke and carbon monoxide gas during operation. These fumes can be harmful if the appliance is used in any other than a fully vented fireplace.

WARNING

The Commonwealth of Massachusetts requires that the chimney flue damper, when used with decorative gas log sets, be welded open or completely removed. In the Commonwealth of Massachusetts, this appliance must be installed by a licensed plumber or gasfitter.

WARNING

Improper installation, adjustment, alteration, service or maintenance, can cause property damage, personal injury or loss of life. Refer to the owner's information manual, provided with this appliance. Installation and service must be performed by a qualified installer, service agency or the gas supplier.

GAS WARNING ODOR

If a gas leak happens, you should be able to smell the gas because of the odorant put in the propane gas. That's your signal to go into immediate action!

- Do not operate electric switches, light matches, use your phone. Do not do anything that could ignite the gas.
- Get everyone out of the building, vehicle, trailer, or area. Do that IMMEDIATELY.
- Close all gas tank or cylinder supply valves.
- Propane gas is heavier than air and may settle in low areas such as basements. When you have reason to suspect a gas leak, keep out of basements and other low areas. Stay out until firefighters declare them to be safe.
- Use your neighbor's phone and call a trained propane gas service person and the fire department. Even though you may not continue to smell gas, do not turn on the gas again. Do not re-enter the building, vehicle, trailer, or area.
- **Finally**, let the service man and firefighters check for escaped gas. Have them air out the area before you return. Properly trained propane gas service people should repair the leak, then check and relight the gas appliance for you.

SAFETY INFORMATION FOR USERS OF PROPANE GAS

Propane is a flammable gas which can cause fires and explosions. In its natural state, propane is odorless and colorless. You may not know all the following safety precautions which can protect both you and your family from an accident. Read them carefully now, then review them point by point with the members of your household. Someday when there may not be a minute to lose, everyone's safety will depend on knowing exactly what to do. If, after reading the following information, you feel you still need more information, please contact your gas supplier.

NO ODOR DETECTED - ODOR FADE

Some people cannot smell well. Some people cannot smell the odor of the chemical put into the gas. You must find out if you can smell the odorant in propane. Smoking can decrease your ability to smell. Being around an odor for a time can affect your sensitivity or ability to detect that odor. Sometimes other odors in the area mask the gas odor. People may not smell the gas odor or their minds are on something else. Thinking about smelling a gas odor can make it easier to smell.

The odorant in propane gas is colorless, and it can fade under some circumstances. For example, if there is an underground leak, the movement of the gas through soil can filter the odorant. Odorants in propane gas also are subject to oxidation. This fading can occur if there is rust inside the storage tank or in iron gas pipes.

The odorant in escaped gas can adsorb or absorb onto or into walls, masonry and other materials and fabrics in a room. That will take some of the odorant out of the gas, reducing its odor intensity.

Propane gas may stratify in a closed area, and the odor intensity could vary at different levels. Since it is heavier than air, there may be more odor at lower levels. Always be sensitive to the slightest gas odor. If you detect any odor, treat it as a serious leak. Immediately go into action as instructed earlier.

SOME POINTS TO REMEMBER

- **Learn to recognize the odor of propane gas.** Your local propane gas dealer can give you a "Scratch and Sniff" pamphlet. Use it to find out what the propane odor smells like. If you suspect that your propane gas has a weak or abnormal odor, call your propane gas dealer.
- If you are not qualified, do not light pilot lights, perform service, or make adjustments to appliances on the propane gas system. If you are qualified, consciously think about the odor of propane gas prior to and while lighting pilot lights or performing service or making adjustments.
- Sometimes a basement or a closed-up house has a musty smell that can cover up the propane gas odor. Do not try to light pilot lights, perform service, or make adjustments in an area where the conditions are such that you may not detect the odor if there has been a leak of propane gas.
- Odor fade, due to oxidation by rust or adsorption on walls of new cylinders and tanks, is possible. Therefore, people should be particularly alert and careful when new tanks or cylinders are placed in service. Odor fade can occur in new tanks, or reinstalled old tanks, if they are filled and allowed to set too long before refilling. Cylinders and tanks which have been out of service for a time may develop internal rust which will cause odor fade. If such conditions are suspected to exist, a periodic sniff test of the gas is advisable. **If you have any question about the gas odor, call your propane gas dealer. A periodic sniff test of the propane gas is a good safety measure under any condition.**
- If, at any time, you do not smell the propane gas odorant and you think you should, assume you have a leak. Then take the same immediate action recommended above for the occasion when you do detect the odorized propane gas.
- If you experience a complete "gas out," (the container is under no vapor pressure), turn the tank valve off immediately. If the container valve is left on, the container may draw in some air through openings such as pilot light orifices. If this occurs, some new internal rusting could occur. If the valve is left open, then treat the container as a new tank. Always be sure your container is under vapor pressure by turning it off at the container before it goes completely empty or having it refilled before it is completely empty.

GENERAL INFORMATION

Qualified Installing Agency

Installation and replacement of gas piping, gas utilization equipment or accessories and repair and servicing of equipment shall be performed only by a qualified agency. The term "qualified agency" means any individual, firm, corporation or company which either in person or through a representative is engaged in and is responsible for (a) the installation or replacement of gas piping or (b) the connection, installation, repair or servicing of equipment, who is experienced in such work, familiar with all precautions required and has complied with all the requirements of the authority having jurisdiction.

Commonwealth of Massachusetts: The installation must be made by a licensed plumber or gas fitter in the Commonwealth of Massachusetts.

The installation and the provisions for combustion and ventilation air must conform with the *National Fuel Gas Code, ANSI Z223.1/ NFPA54** Canadian Installation Code *CAN/CGA B149*.
**Available from the American National Standards Institute, Inc. 11 West 42nd St., New York, N.Y. 10018.*

High Altitude Installation

When installing this unit at an elevation above 2000 feet (in the United States) it may be necessary to decrease the input rating by changing the existing burner orifice to a smaller size. Generally, input should be reduced 4 percent for each 1000 feet above sea level. However, if the heating value of the gas has been reduced, this general rule may not apply. Check with local gas utility for proper orifice size identification.

For Canadian high altitude applications, this appliance is suitable for installation at elevations between 0 feet (0m) and 4,500 (1,370m) without change.

When installing this unit at an elevation above 4500 feet (1,370m) (in Canada), check with local authorities.

Consult your local gas utility for assistance in determining the proper orifice for location.

PRODUCT SPECIFICATIONS

		NATURAL GAS
		Millivolt
Regulator pressure setting		4.5"
Gas inlet pressure	Max.	10.5"
	Min.	5.0"

Model	Gas Type	Valve Type	Orifice	Manifold Pressure (w.c.)	BTUH Max. Rate
BFR2124RN	Natural	Hi/Low	#22	4.5"	55,000
BFR30RN	Natural	Hi/Low	#12	4.5"	65,000

PROPANE CONVERSION KIT		
Burner Model	Valve Type	Kit Number
BFR2124RN	Hi/Low	CKV119
BFR30RN	Hi/Low	CKV120

NOTE: The air shutter setting for all models is 1/16" open.

Determining the Correct Burner Size for Your Fireplace

MINIMUM FIREPLACE DIMENSIONS FACTORY BUILT FIREPLACES					
Chimney Height Minimum of 6 Feet					
Burner Model	Rear Width A	Depth B	Front Width C	Height D	Minimum Vent in Sq. Inches
BFR2124RN	26	16	30	20	49
BFR30RN	30	16	36	20	49

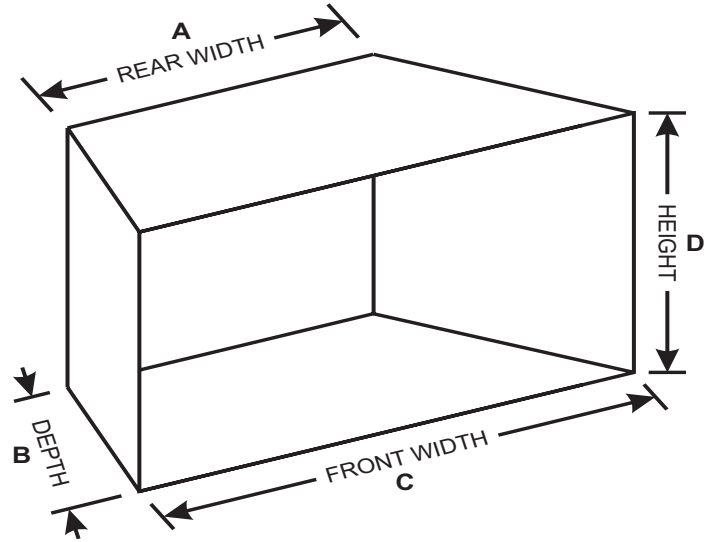

Figure 1

INTRODUCTION

Introduction

Always consult your local Building Department regarding regulations, codes or ordinances which apply to the installation of a vented decorative gas log set in a solid-fuel burning fireplace. This appliance is only for use with the type of gas indicated on the rating plate.

Instructions to Installer

1. Installer must leave instruction manual with owner after installation.
2. Installer must have owner fill out and mail warranty card supplied with the fireplace.
3. Installer should show owner how to start and operate the fireplace.

⚠ WARNING

Any change to this appliance or its controls can be dangerous. Improper installation or use of the appliance can cause serious injury or death from fire, burns, explosion or carbon monoxide poisoning.

General Information

Any alteration of the original design, installed other than as shown in these instructions or use with a type of gas not shown on the rating plate is the responsibility of the person and company making the change.

Important

All correspondence should refer to complete Model No., Serial No. and type of gas. This information can be found on the data plate supplied with the burner.

NOTICE: During initial use of the logs you will detect an odor as the logs are cured. This is normal.

⚠ WARNING

A fireplace screen must be in place when this appliance is in operation. The screen shall allow for introduction of combustion air.

⚠ WARNING

When this decorative gas appliance is used in a fireplace equipped with glass doors, the glass doors should remain open during log set operation. This will maximize the radiant heat provided to the surrounding area, and minimize overheating of any valve installation. The glass doors may be closed when the log set is not in use.

FIREPLACE PREPARATION

- Remove all contents from the burner carton.
- Check the contents of the carton against the parts list in this manual. Report any missing or damaged parts to your dealer.
- Turn off gas supply to fireplace or firebox.
- Have the fireplace floor and chimney professionally cleaned to remove ashes, soot, creosote or other obstructions. Have this cleaning performed annually after installation.
- Seal any fresh air vents or ash clean-out doors located on floor or wall of fireplace. If not, drafting may cause pilot outage or excessive sooting. Use a heat-resistant sealant. Do not seal chimney flue damper.

Installing Damper Clamp

Remove all ashes or other debris from the fireplace. If the fireplace is equipped with an ash dump be sure to seal the door with furnace cement or high temperature silicone. Be sure to check the damper for proper operation and verify that the flue passageway is open. Attach damper clamp to the vent damper and tighten hold down bolt.

Place the clamp over the lip of the damper and tighten the hold down bolt until the clamp is securely attached to the damper. This will prevent the damper from accidentally closing.

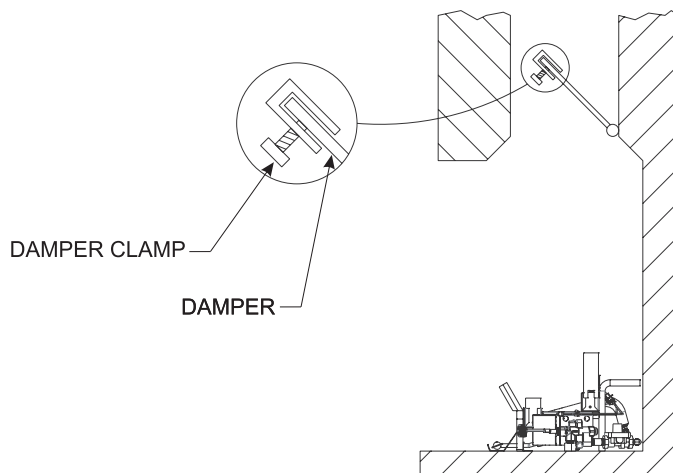

TYPICAL FIREPLACE

Figure 2

GAS SUPPLY

Check all local codes for requirements, especially for the size and type of gas supply line required.

RECOMMENDED GAS PIPE DIAMETER				
Pipe Length	Schedule 40 Pipe Inside Diameter		Tubing, Type L Outside Diameter	
	Natural	Propane	Natural	Propane
0-10 feet	1/2-in	3/8-in	1/2-in	3/8-in
10-40 feet	1/2-in	1/2-in	5/8-in	1/2-in
40-100 feet	1/2-in	1/2-in	3/4-in	1/2-in
100-150 feet	3/4-in	1/2-in	7/8-in	3/4-in

NOTICE: Never use plastic pipe. Check to confirm whether your local codes allow copper tubing or galvanized.

NOTICE: Since some municipalities have additional local codes, it is always best to consult your local authority and installation code.

Installing a New Main Gas Shut-Off Valve

Each appliance should have its own manual gas shut-off valve.

In the Commonwealth of Massachusetts the gas shut-off valve must be a T handle type.

A manual main gas shut-off valve should be located in the vicinity of the unit. Where none exists, or where its size or location is not adequate, contact your local authorized installer for installation or relocation.

Compounds used on threaded joints of gas piping shall be resistant to the action of liquefied petroleum gases. The gas lines must be checked for leaks by the installer. Testing for leaks on all exposed connections should be done with leak detection test solution. After testing is complete, all solution should be cleaned off. On unexposed connections, a pressure test should be made.

Never use an exposed flame to check for leaks. Appliance must be disconnected from piping at inlet of control valve and pipe capped or plugged for pressure test. Never pressure test with appliance connected; control valve will sustain damage!

A gas valve and ground joint union should be installed in the gas line upstream of the gas control to aid in servicing. It is required by the National Fuel Gas Code that a drip line be installed near the gas inlet. This should consist of a vertical length of pipe tee connected into the gas line that is capped on the bottom in which condensation and foreign particles may collect.

The use of the following gas connectors is recommended:

- ANSI Z21.24 Appliance Connectors of Corrugated Metal Tubing and Fittings
- ANSI Z21.45 Assembled Flexible Appliance Connectors of Other Than All-Metal Construction

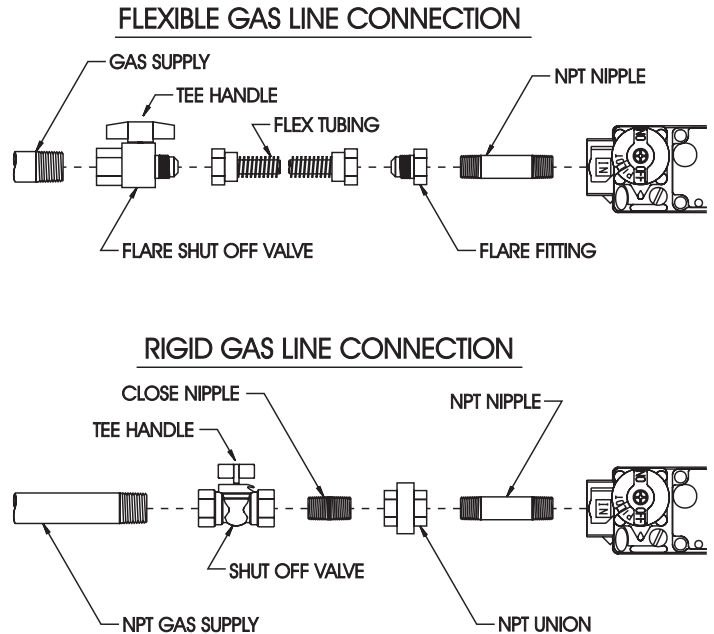

Figure 3

The above connectors may be used if acceptable by the authority having jurisdiction. The Commonwealth of Massachusetts requires that a flexible appliance connector cannot exceed three feet in length. A gas valve and ground joint union should be installed in the gas line upstream of the gas control to aid in servicing. It is required by the National Fuel Gas Code that a drip leg be installed near the gas inlet. See Figure 4. This should consist of a vertical length of pipe tee connected into the gas line that is capped on the bottom in which condensation and foreign particles may collect.

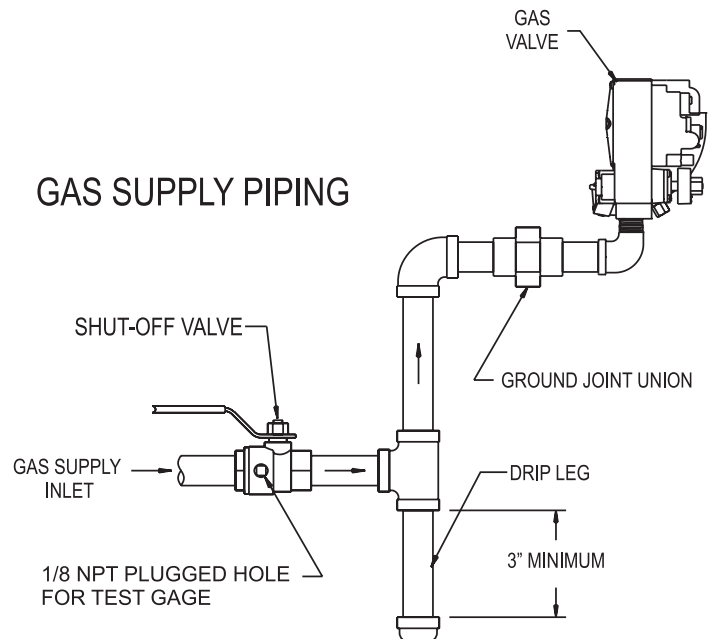

Figure 4

GAS SUPPLY (CONT'D)

Pressure Testing of the Gas Supply System

1. To check the inlet pressure to the gas valve, use the test gauge connection described below.
2. The appliance and its individual shutoff valve must be disconnected from the gas supply piping system during any pressure testing of that system at test pressures in excess of 1/2 psig (3.5 kPa).
3. The appliance must be isolated from the gas supply piping system by closing its individual manual shutoff valve during any pressure testing of the gas supply piping system at test pressures equal to or less than 1/2 psig (3.5 kPa).

CAUTION

If one of the procedures results in pressures in excess of 1/2 psig (14-in w.c.) (3.5 kPa) on the appliance gas valve, it will result in a hazardous condition.

Checking Manifold Pressure

Natural Gas models will have a manifold pressure of approximately 4.5-in w.c. (1.12kPa) at the pressure regulator outlet with the inlet pressure to the pressure regulator from a minimum of 5.0-in w.c. (1.120kPa) for the purpose of input adjustment to a maximum of 10.5-in w.c. (2.615kPa).

***NOTICE:** The gas control is equipped with a captured screw-type test gauge connection.

INSTALLATION

Gas supply system must be installed in accordance with the U.S. National Fuel Gas Code.

This appliance and its individual shut off valve must be disconnected from the gas supply piping system during any system pressure test in excess of 1/2 PSI (3.5 KPA).

Use a system manual shut off valve to shut off the gas supply to this gas appliance before continuing with installation procedures.

⚠ DANGER

To avoid injury and property damage, **DO NOT obstruct the flow of combustion and ventilation air when installing or operating the appliance.**

IMPORTANT

Seal any fresh air vents or ash clean-out doors located on the floor or wall of the fireplace. If this is not performed, drafting may cause pilot outage or excessive sooting. Use a heat-resistant sealant. **DO NOT seal the chimney flue damper.**

IMPORTANT

BEFORE YOU BEGIN - Check the gas pressure at the fireplace stub to ensure proper minimum gas pressure (see the specifications beginning on page 9 of this manual).

IMPORTANT

BEFORE YOU BEGIN - Ensure that the firebox meets the minimum specifications of the appliance (see the specifications beginning on page 9 of this manual).

IMPORTANT

This appliance when first installed and used may produce odors. This is normal. Open a window when operating the appliance for the first time.

IMPORTANT

This appliance must be installed only in a solid-fuel burning fireplace, which contains a working flue and is constructed of non-combustible materials.

You must secure the gas burner to the fireplace floor. If not, the entire unit may move when you adjust the controls. Movement of unit may cause shifting of the gas logs which leads to excessive sooting and improper burning. See Figure 5.

Special care is required if you are installing the unit into a sunken fireplace. You must raise the fireplace floor with non-combustible material to allow access to gas log controls. This will ensure adequate air flow and guard against sooting. Raise the fireplace floor using noncombustible materials.

ASSEMBLY PROCEDURE:

1. Place the burner in the fireplace or firebox. Make certain the entire ember burner is inside the front edge of the fireplace or firebox.
2. An anchor hole is provided in each burner leg. After centering the burner, mark the hole positions on the fireplace/firebox floor. Drill two 5/32 inch diameter holes approximately 1-1/2 inches deep for masonry screws or 1/8 inch hole for sheet metal screws.
3. Anchor to the fireplace/firebox floor using the screws provided. Refer to **Figure 5**.

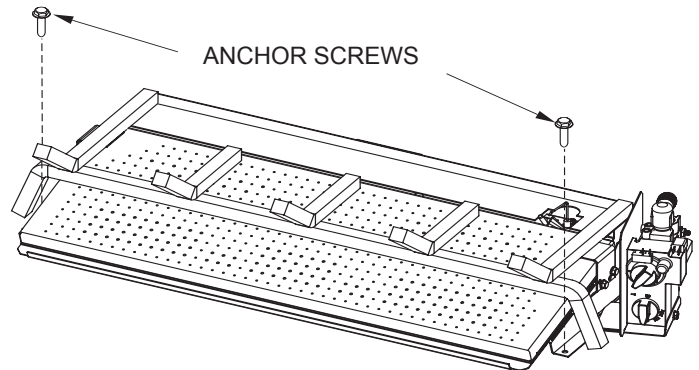
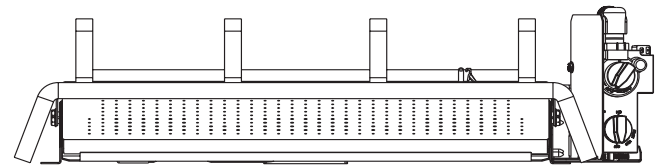

Figure 5



BFR MODEL FRONT AND REAR

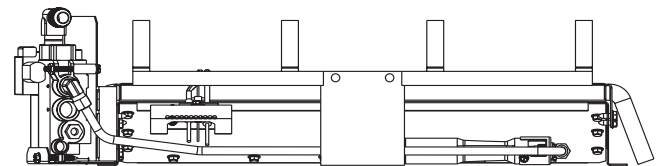

Figure 6

INSTALLATION (CONT'D)

⚠ WARNING

Failure to position the parts in accordance with all included pictures, diagrams and drawings, or failure to use only parts specifically approved with this appliance may result in property damage or personal injury.

4. Spread the rock wool over the burner. The rock wool should be broken into fluffy quarter-sized pieces.

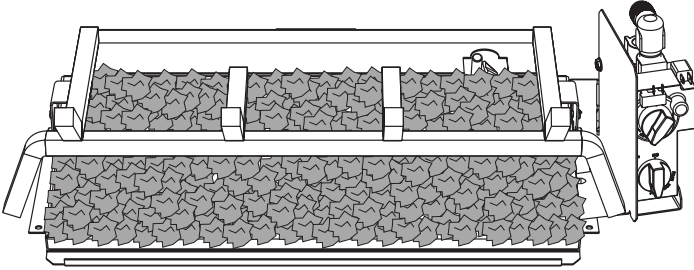

Figure 7

5. Place the lava rock around the burner assembly.

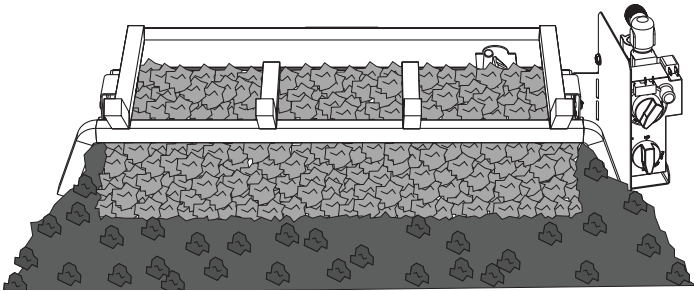

Figure 8

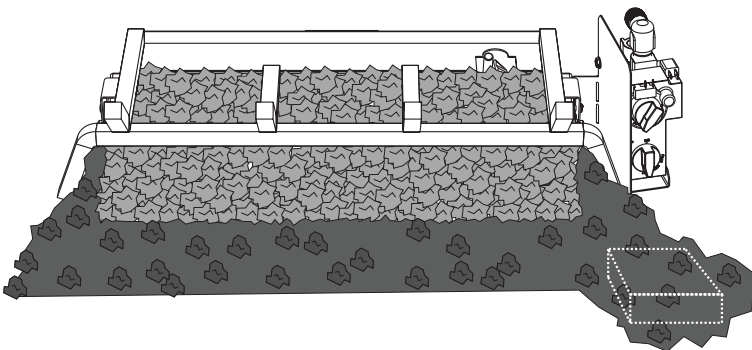

Figure 9

6. Place remote receiver in the front right corner of firebox and cover with lava rock as shown in **Figure 9**.

⚠ WARNING

Apply loose material (rockwool and lava rock) per instruction manual. **DO NOT** apply extra material not supplied with this appliance. All previously applied loose material (rock wool) must be removed prior to reapplication.

⚠ CAUTION

DO NOT place rockwool or lava rock in the area of the safety pilot assembly.

STOP!

The LKF Fiber Log Set and LPR2430 Refractory Log Set are the only two log sets which are approved for use on these burners. **DO NOT** substitute a different log set or deviate from the log placement sequence.

Refer to the instructions packaged with your Decorative Gas Logs.

7. Remove all contents from the Decorative Gas Log carton.
8. Check the contents of the carton against the parts list in the manual. Report any missing or damaged parts to your retailer.
9. Remove any and all protective wrapping from the gas logs.
10. Arrange the decorative gas logs on the burner according to the instructions.

NOTICE: The Commonwealth of Massachusetts requires that the chimney flue damper, when used with decorative gas log sets, be welded open or completely removed.

DOOR OPERATION

⚠ CAUTION

Operate the fireplace with the bifold glass doors in only the fully open position.

NOTE: Always close the mesh firescreens when operating the fireplace with the glass doors fully open.

CORRECT DOOR POSITION WHEN OPERATING THE FIREPLACE



FULLY OPEN DOORS

Figure 10

INCORRECT DOOR POSITION WHEN OPERATING THE FIREPLACE

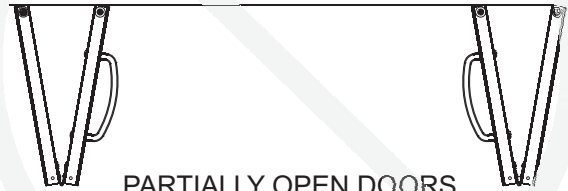

PARTIALLY OPEN DOORS.

⚠ WARNING

DO NOT operate the fireplace with the doors partially open or closed. Operating the fireplace with the doors partially open or closed creates a hazardous situation.

- Partially open doors can cause sooting on front of the fireplace.
- Closed doors can cause the glass to overheat and shatter.

Figure 11

HI / LOW LIGHTING INSTRUCTIONS

FOR YOUR SAFETY READ BEFORE LIGHTING

⚠ WARNING







If you do not follow these instructions exactly, a fire or explosion may result causing property damage, personal injury or loss of life.

- A. This appliance has a pilot which must be lighted by hand. When lighting the pilot, follow these instructions exactly.
- B. **BEFORE LIGHTING** smell all around the appliance area for gas. Be sure to smell next to the floor because some gas is heavier than air and will settle on the floor.
- WHAT TO DO IF YOU SMELL GAS**
- Do not try to light any appliance.
 - Do not touch any electrical switch; do not use any phone in your building.
 - Immediately call your gas supplier from a neighbor's phone. Follow the gas supplier's instructions.
 - If you cannot reach your gas supplier, call the fire department.
- C. Use only your hand to push in or turn the gas control knob. Never use tools. If the knob will not push in or turn by hand, don't try to repair it; call a qualified service technician. Force or attempted repair may result in a fire or explosion.
- D. Do not use this appliance if any part has been under water. Immediately call a qualified service technician to inspect the appliance and to replace any part of the control system and any gas control which has been under water.

LIGHTING INSTRUCTIONS

⚠ WARNING

- Any glass doors shall be opened when the appliance is in operation.
- A fireplace screen must be in place when the appliance is operating and the screen shall have an opening(s) for introduction of combustion air.

1. STOP! Read the safety information or other side of plate.
2. Push in gas control knob slightly and turn clockwise  to "OFF". Do not force.
3. Turn gas flow adjustment knob clockwise  either manually or with remote control to "OFF".
4. Wait ten (10) minutes to clear out any gas. Then smell for gas, including near floor. If you smell gas, STOP! follow "B" in the safety information on other side. If you do not smell gas, go to the next step.
5. Find pilot - the pilot is attached to the rear-right of the burner.
6. Turn gas control knob counterclockwise  to "IGN".
7. Depress and turn gas control knob counterclockwise  to "PILOT". A spark is produced when gas control knob is turned between "IGN" and "PILOT". Repeatedly depress and turn gas control knob between "IGN" and "PILOT" until pilot is ignited. Continue to hold the control knob in for about one (1) minute after pilot is lit. Release knob and it will pop back up. Pilot should remain lit. If it goes out repeat steps 2 through 7.
 - If knob does not pop up when released, stop and immediately call your service technician or gas supplier.
 - If the pilot will not stay lit after several tries, turn the gas control knob to "OFF" and call your service.
8. Attention! Gas control has an INTERLOCK latching device. When the pilot is initially lit and the safety magnet is energized (pilot stays on) the INTERLOCK latching device becomes operative. If the gas control is turned to the "OFF" position or gas flow to the appliance is shut off, the pilot cannot be relighted until the safety magnet is de-energized (approximately 60 seconds). There will be an audible "click" when the safety magnet in the gas control is de-energized. Pilot can now be relighted. Repeat step 2 through 7.
9. Turn gas control knob counterclockwise  to "ON".
10. Turn gas flow adjustment knob counterclockwise  either manually or with remote control between "OFF" and "ON" to adjust flame height.

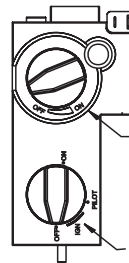

GAS FLOW ADJUSTMENT KNOB SHOWN IN "OFF" POSITION.

GAS CONTROL KNOB SHOWN IN "OFF" POSITION.

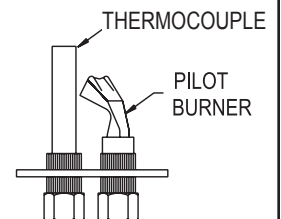

TO TURN OFF GAS TO APPLIANCE

1. Set the ON/OFF switch to "OFF".
2. Push in gas control knob slightly and turn clockwise  to "OFF". Do not force.

PILOT AND MAIN BURNER FLAME CHARACTERISTICS

Pilot Flame Pattern

Figure 12 shows a correct pilot flame pattern. The correct flame will be blue and will extend beyond the thermocouple. The flame will surround the thermocouple just below the tip. A slight yellow flame may occur where the pilot flame and main burner flame meet.

After use, cleaning of the pilot burner may be required for the proper flame. The pilot orifice can be cleaned with high pressure air or by placing under running water. Pilot orifice must be dry before replacement. Use canned air to clean inside the pilot after the pilot orifice has been removed.

To Remove Pilot Orifice

1. Disconnect the pilot supply line at the pilot burner.
2. Remove pilot orifice from pilot burner. It may be necessary to tap on pilot burner in order to remove the pilot orifice.

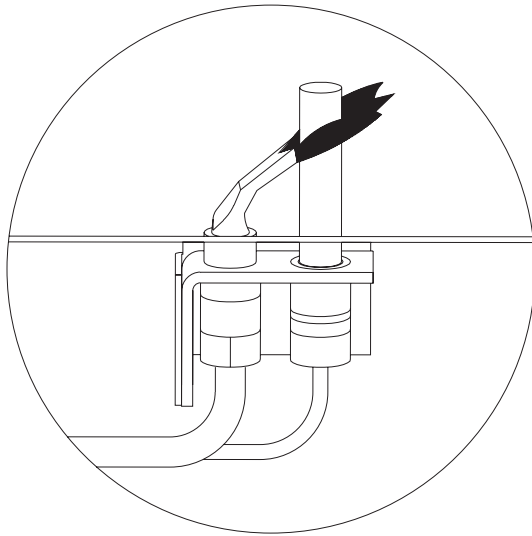

Pilot Flame Pattern
Figure 12

If pilot flame pattern is incorrect-

- See Troubleshooting, page 21.

Main Burner Flame Pattern

The main burner flame will be yellow with a blue base.

Main Burner Flame Ignition and Extinction

When the main burner is ignited it will take a few seconds for the full flame pattern to develop.

When the main burner is extinguished it will take a few seconds for the flames to disappear. It is normal to have the flames burn down near the rock wool, as the remaining gas is burned.

HI / LOW (BFR) WIRING

NOTICE: Thermostats are not approved on vented decorative appliances.

Label all wires prior to disconnection when servicing controls. Wiring errors can cause improper and dangerous operation. Verify proper operation after servicing.

The gas valve does not require 24 or 110 volts. See pages 19 - 21 for remote control instructions.

It is important to use wire of a proper gauge for the length of the wire:

RECOMMENDED WIRE GAUGES	
Maximum Length	Wire Gauge
1' to 10'	18
10' to 25'	16
25' to 35'	14

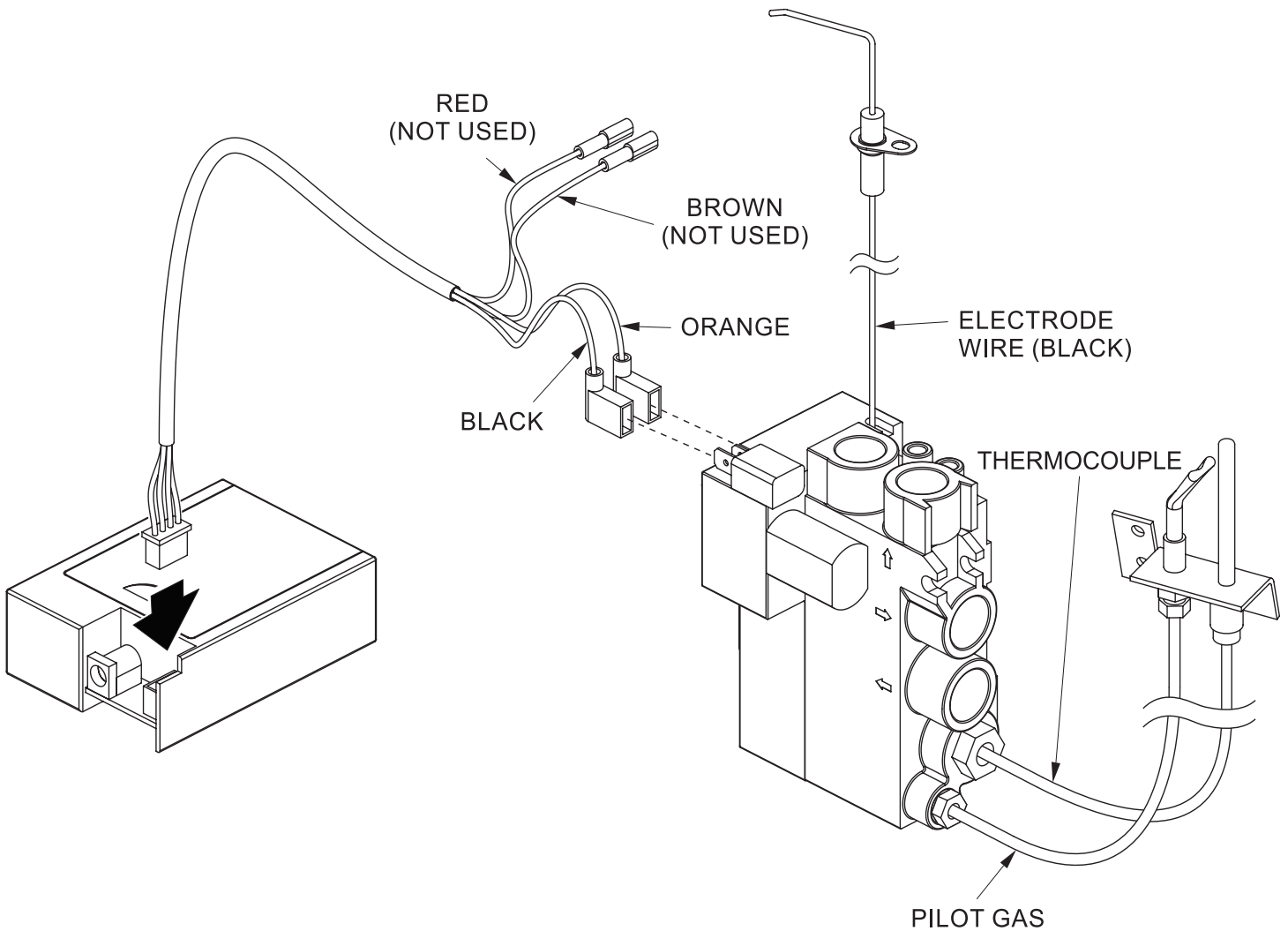

Wiring Diagram
Figure 13

Remote Receiver

Use the following steps to place the **remote receiver** adjacent to the gas valve.

Attention:

1. The remote receiver cannot be placed behind the gas valve and burner assembly.
2. When facing the appliance, the remote receiver must be placed in the **right** side firebox, toward the front.

NOTICE: Do not let remote control receiver come in contact with burner assembly.

Refer to remote control installation and operating instructions for more details on remote control.

REMOTE OPERATION

APPLICATION

GV34 is a servo motor operated valve with remote control allowing for infinite adjustment from low fire to high fire.

GENERAL NOTES

Radio Frequency Remote

868 MHz for Europe; 915 MHz for U.S. (FCC ID: UX5-R300) and for Canada (IC: 4943-R300). This device complies with part 15 of the FCC Rules. Operation is subject to the following two conditions: (1) This device may not cause harmful interference, and (2) This device must accept any interference received, including interference that may cause undesired operation. Changes or modifications not expressly approved by the party responsible for compliance could void the user's authority to operate the equipment.

Batteries -

Remote Handset:
2 X 1.5V "AAA"
(quality alkaline recommended)

Batteries -

Receiver:
4 X 1.5V "AA"
(quality alkaline recommended).

Battery

Replacement

Battery replacement is recommended at the beginning of each heating season. Do not use metal tools to remove batteries. Using a metal tool could cause a short that may damage the receiver.

Location Of Receiver

See page 14.



STANDARD HANDSET FEATURES



Figure 14:
R300 Standard
Model, Patented

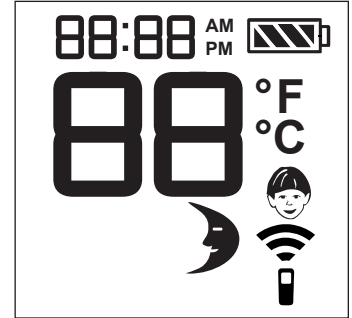







Figure 15:
R300 Standard
Model Icons

LCD Icon	Features And Description
	Sleep Mode Icon. After 8 hours of no signal between the handset and the receiver, valve runs to pilot and Sleep Mode icon is displayed.
	Ambient Temperature Display: Indicates the current room temperature. °F or °C
	Child Safety Lock: When ON (icon showing), the right button must be pushed twice within 0.5 seconds to increase the flame height.
	Battery Life Indicator: 4 bars indicates a fully charged battery.
	Clock Mode: Set to 12 or 24 hour clock.
	Communication Indicator: Indicates the handset is transmitting to the receiver.

INITIAL SETUP

SETTING THE ELECTRONIC CODE

Radio Frequency Remote

A code is selected automatically for all Mertik Maxitrol electronics from among 65,000 random codes available.

On initial and subsequent receiver battery changes, the receiver has to learn the code of the handset.

- Power up Handset
- Power up Receiver (LED blinks).
- While blinking, press any button.
- When the Receiver LED stops blinking, the code is set.

NOTE: These remote handset and receiver are not interchangeable with previous versions. For all lighting instructions please refer to appliance manufacturer's instructions.

REMOTE OPERATION (CONT'D)

⚠ WARNING

Read through this entire warning before attempting initial setup / programming.



A red number/icon indicates the icon is blinking. This will help determine which menu item is being set or programmed.

When programming a menu item, use the right (up) button **ONLY**. Pressing the left (down) button will cause the programming menu to skip to the next menu item. If you accidentally skip to the next menu item, you must cycle through all the menu items to return to the item you were programming.

When adjusting a menu item, the number will scroll up only (1, 2, 3...) and will cycle back to the beginning number.



15 seconds of inactivity will cause the remote to automatically go to operation mode. Follow Step 1. **INITIAL SETUP - PROGRAMMING MODE** to return to programming mode. Any changes will be saved each time you exit programming mode.

INITIAL SETUP - PROGRAMMING MODE

- Press  (both buttons) and hold for 5 seconds (until screen blinks) to enter Programming Mode.
- Press  (down) to scroll through menu items.
- Press  (up) to adjust menu items.



SETTING °F OR °C



1. Press  (up) button to choose either °F or °C.
- Press  (down) button to set and scroll to the next menu item.



SETTING 12 HOUR OR 24 HOUR MODE



2. Press  (up) button to choose either "12" or "24".
- Press  (down) button to set and scroll to the next menu item.

SETTING THE HOUR





3. Press  (up) button to set the Hour, 1-12 or 0-23.
NOTE: Use the (up) button only. Numbers scroll up (1, 2, 3,...) to 12 or 23 then cycle back to 1 or 0.
- Press  (down) button to set and scroll to the next menu item.

PAGE 3

INITIAL SETUP - PROGRAMMING MODE (CONT'D)

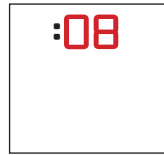
SETTING THE MINUTES



4. Press  (up) button to set Minutes. 00-59.
NOTE: Use right (up) button only. Numbers scroll up (1, 2, 3...) to 59 then cycle back to 00.
- Press  (down) button to set and scroll to the next menu item.

SETTING CHILD SAFETY LOCK





5. Set Child Safety Lock either ON or OFF.
- Press  (up) button to set Child Safety Lock ON (icon showing) or OFF.

This concludes your basic programming. The remote will automatically save your changes and go to operation mode after 15 seconds of inactivity.

STANDARD HANDSET OPERATION

FLAME HEIGHT ADJUSTMENT

- To turn the main burner ON or to increase the flame height, press the  (up) button.
- To decrease the flame height, press the  (down) button or turn main burner OFF.



REMOTE OPERATION (CONT'D)

SLEEP MODE

After 8 hours of no signal between the handset and the receiver valve runs to pilot and the  Sleep Mode icon is displayed.







TURN OFF GAS TO APPLIANCE

Access the gas control.

Turn the main valve knob clockwise  to the PILOT position. Push in knob; turn and release. Continue turning to the OFF full clockwise  position.

Replace appliance accessibility cover (if applicable).

MANUAL VALVE OPERATION

1. STOP! Read the safety information included before proceeding.
2. Turn main valve knob to the OFF full clockwise  position.
3. Turn the MANUAL knob to the full clockwise  position. **See Figure 16.**
4. Wait five (5) minutes to clear out any gas. Verify that no gas is in the area around the appliance, including near the floor. **If you detect gas STOP! Follow WARNINGS (see pg. 16) under “What to do if you smell gas”.** If no gas is present, proceed to step 5.
5. Turn main valve knob slightly counterclockwise  towards the IGN position until it stops, then press down and continue turning counterclockwise  to the pilot position. Continue to hold down knob for 10 seconds after pilot burner has been lit. If pilot does not light, steps 1 and 2 may be repeated. **NOTE:** If the pilot does not stay lit after several tries, turn main valve knob to the PILOT position. Push in knob; turn and release. Continue turning to the OFF full clockwise  position and proceed to step 7.
6. Upon lighting, release knob and turn main valve knob fully counterclockwise  to ON position.
7. If the appliance will not operate, follow the instructions “Turn Off Gas to Appliance”.

MANUAL FLAME HEIGHT OPERATION

The motorized valve is equipped with a slip clutch allowing manual adjustment of the main burner by turning the manual knob. When turning the manual knob, do not force.

STANDBY PROCEDURE

Turn main valve knob clockwise  to Pilot position, allowing only pilot gas to flow.

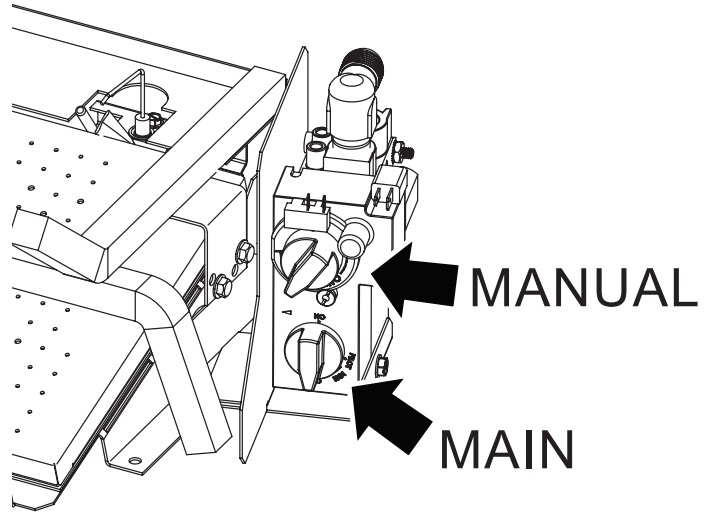

Figure 16

MAINTENANCE AND SERVICE

Maintenance

The Decorative Gas Log Set should be thoroughly inspected at least once a year by a qualified technician.

At the beginning of each season, check for:

- Chimney flue or vent pipe is drawing properly, and that vent pipe connections are tight.
- Blockages at the chimney or vent termination.
- Creosote and soot build-up in chimney and/or vents (clean if necessary).
- Inspect the pilot and burners.
- Remove dust, cobwebs, pet hair or other debris from the fireplace.
- Check for gas leaks. See page 11.

The burner system has been adjusted for proper operation at the factory. No adjustment is necessary, other than altitude de-rate or pilot flame.

WARNING

NEVER enlarge valve orifices or burner ports.

Sooting

Some sooting of your log set is normal, adding to the appearance of burned wood. If excessive sooting accumulates, clean the logs using either of the following options::

- A. When the logs are cold, remove logs from burner, brush the soot off with a brush. Do not use water or soot cleaners.
- B. When the logs are cold, remove logs from burner. Take logs outside and remove soot with an air hose. Refer to Installation Instructions supplied with logs for re-installation information.

Cleaning

Keep the control area, logs and burner area surrounding the logs clean.

THE LOGS CAN GET VERY HOT—HANDLE ONLY WHEN COOL.

Always keep the appliance area clear and free from combustible materials, gasoline, and other flammable vapors and liquids.

Never obstruct the flow of combustion and ventilation air. Keep the front of the appliance clear of all obstacles and materials.

Inspecting Venting System

A vented fireplace venting system is designed and constructed to develop a positive flow adequate to remove flue gases to the outside atmosphere.

Any foreign objects in the venting system, may cause flue gases to flow into the room.

Periodic examination and/or cleaning of the venting system of the solid-fuel burning fireplace must be done by a qualified service person. Visually inspect the damper and flue area for excessive soot build-up. This soot (carbon) may be removed by brushing with a soft bristle brush.

TROUBLESHOOTING

PROBLEM OBSERVED	POSSIBLE CAUSE	CORRECTIVE MEASURE
Gas odor during setup	Gas Leak	What To Do If You Smell Gas • Do not try to light any appliance. • Do not touch any electrical switch; do not use any phone in your building. • Immediately call your gas supplier from a neighbor's phone. Follow the gas supplier's instructions. • If you cannot reach your gas supplier, call the fire department.
Gas odor before first ignition	Gas Leak	
Pilot will not ignite, or will not stay lit	No gas to pilot	Make sure gas is on, in pilot position
	Thermocouple not hot	Depress valve knob for at least 1 minute
	Improper pilot flame adjustment	See Pilot Characteristics - adjust flame
	Loose connections on the thermocouple	Check gas connections
	Faulty pilot or thermocouple	Replace Safety Pilot
	Faulty valve	Replace Valve
Delayed ignition	Low gas pressure	Check gas supply pressure
	Clogged or dirty burner ports	Clean burner ports
	Blocked orifice	Check orifice opening
	Faulty valve	Replace valve
Burner does not light but pilot remains on	Low gas pressure	Check gas supply pressure
	Clogged or dirty burner ports	Clean burner ports
	Blocked orifice	Check orifice opening
	Faulty pilot or thermocouple	Replace safety pilot
	Faulty valve	Replace valve
Burner lights but does not stay lit while pilot remains on	Low gas pressure	Check gas supply pressure
	Faulty valve	Replace valve
	Faulty pilot or thermocouple	Replace Safety pilot
	Clogged or dirty burner ports	Clean burner ports
Burner & pilot light but will not stay on	Low gas pressure	Check gas supply pressure
	Not enough fresh air for pilot	Open door or window - ventilate
	Faulty valve	Replace valve
	Faulty pilot or thermocouple	Replace safety pilot
	Clogged or dirty burner ports	Clean burner ports
	Remote control overheating	Move away from flame
	Remote control batteries failing	Replace batteries
Incorrect burner flame	Incorrect gas supply or pressure	Check gas supply pressure
	Blocked orifice	Check orifice opening
	Clogged or dirty burner ports	Clean burner ports
	Faulty valve	Replace valve
	High altitude	Adjust orifice size for altitude
Backfire of burner	Blocked orifice	Check orifice opening
	Clogged or dirty burner ports	Clean burner ports
	Low gas pressure	Check gas supply pressure
Appliance produces unwanted odors	Vapors from paint, hair spray, glues, etc.	Ventilate room
	Initial burn-off of manufacturing chemicals	Ventilate room
Logs appear to smoke	Vapors from manufacturing chemicals	Ventilate room
	Logs curing	See "Curing of Refractory Logs"
Whistle noise from appliance	Air in gas line	Bleed lines
	Control knob not in fully open position	Open control knob to full position
	Spiral gas flex line	Replace gas feed line

BFR PARTS LIST AND EXPLODED VIEW

⚠ WARNING

Failure to position the parts in accordance with these diagrams or failure to use only parts specifically approved with this appliance may result in property damage or personal injury.

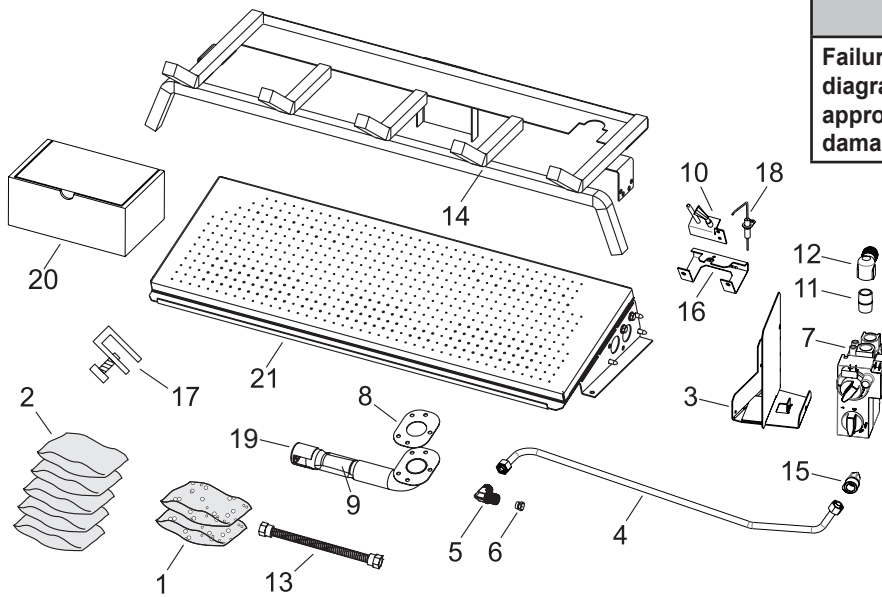

INDEX NO.	PART NO.	DESCRIPTION	USED ON	
1	11788	Decorative Rock	BFR2124	BFR30
2	15496	Rock Wool, .75 oz	BFR2124	BFR30
3	38633	Valve Bracket, Hi/Low	BFR2124	BFR30
4	38340	Tube Assembly, 2124	BFR2124	
	38665	Tube Assembly, 30		BFR30
5	P253	Fitting, Orifice, 90° Angle	BFR2124	BFR30
6	P273	Orifice, #22	BFR2124	
	P325	Orifice, #12		BFR30
7	R12602	Valve, NAT Maxitrol GV34	BFR2124	BFR30
8	R11977	Venturi Gasket	BFR2124	BFR30
9	R11978	Venturi	BFR2124	BFR30
10	R12051	Pilot w/ Thermocouple - (Natural Gas)	BFR2124	BFR30
11	R12059	Nipple, 3/8 X 3/8 X 1 Black Iron	BFR2124	BFR30
12	R12217	Fitting, 1/2 Flare X 3/8 NPT Internal Threads	BFR2124	BFR30
13	R12219	Flex Line, Non-Whistling 16 Inch X 1/2 Flare	BFR2124	BFR30
14	R12624	Grate Weldment, 24	BFR2124	
	R12625	Grate Weldment, 30		BFR30
15	R6207	Elbow 5/16 X 3/8 90	BFR2124	BFR30
16	39028	Electrode Bracket	BFR2124	BFR30
17	R2809	Damper Clamp	BFR2124	BFR30
18	R1155	Electrode	BFR2124	BFR30
19	R7624	Air Shutter	BFR2124	BFR30
20	R12635	Remote And Receiver	BFR2124	BFR30
21	39114	Burner Assembly	BFR2124	
	39115	Burner Assembly		BFR30
NS	38898	Fiber Heat Sink	BFR2124	
	38899	Fiber Heat Sink		BFR30

MASTER PARTS DISTRIBUTOR LIST

To Order Parts Under Warranty, please contact your local Empire dealer. See the dealer locator at www.empirecomfort.com. To provide warranty service, your dealer will need your name and address, purchase date and serial number, and the nature of the problem with the unit.

To Order Parts After the Warranty Period, please contact your dealer or one of the Master Parts Distributors listed below. This list changes from time to time. For the current list, please click on the Master Parts button at www.empirecomfort.com.

Please note: Master Parts Distributors are independent businesses that stock the most commonly ordered Original Equipment repair parts for Heaters, Grills, and Fireplaces manufactured by Empire Comfort Systems Inc.

Dey Distributing

1401 Willow Lake Boulevard
Vadnais Heights, MN 55101

Phone: 651-490-9191

Toll Free: 800-397-1339

Website: www.deydistributing.com

Parts: Heater, Hearth and Grills

F. W. Webb Company

200 Locust Street
Hartford, CT 06114

Phone: 860-722-2433

Toll Free: 800-243-9360

Fax: 860-293-0479

Toll Free Fax: 800-274-2004

Websites: www.fwwebb.com & www.victormfg.com

Parts: Heater, Hearth and Grills

East Coast Energy Products

10 East Route 36
West Long Branch, NJ 07764

Phone: 732-870-8809

Toll Free: 800-755-8809

Fax: 732-870-8811

Website: www.eastcoastenergy.com

Parts: Heater, Hearth and Grills

HOW TO ORDER REPAIR PARTS

Parts Not Under Warranty

Parts can be ordered through your Service Person, Dealer, or a Master Parts Distributor. See this page for the Master Parts Distributors list. For best results, the **service person or dealer** should order parts through the distributor. Parts can be shipped directly to the **service person/dealer**.

Warranty Parts

Warranty parts will need a proof of purchase and can be ordered by your Service Person or Dealer. Proof of purchase is **required** for warranty parts.

All parts listed in the Parts List have a Part Number. When ordering parts, first obtain the Model Number and Serial Number from the name plate on your equipment. Then determine the Part Number (**not** the Index Number) and the Description of each part from the following illustration and part list. Be sure to give all this information . . .

Appliance Model Number _____ Part Description _____

Appliance Serial Number _____ Part Number _____

Type of Gas (Propane or Natural) _____

Do not order bolts, screws, washers or nuts. They are standard hardware items and can be purchased at any local hardware store.

Shipments contingent upon strikes, fires and all causes beyond our control.

WARRANTY

Empire Comfort Systems Inc. warrants this hearth product to be free from defects at the time of purchase and for the periods specified below. Hearth products must be installed by a qualified technician and must be maintained and operated safely, in accordance with the instructions in the owner's manual. This warranty applies to the original purchaser only and is not transferable. All warranty repairs must be accomplished by a qualified gas appliance technician.

Limited Lifetime – Refractory Logs

Should any part fail because of defective workmanship or material during the normal life of this product, Empire will repair or replace at Empire's option.

Limited Five-Year Parts Warranty – Burners, Grates, Ceramic Fiber Logs

Should any part fail because of defective workmanship or material within five years from the date of purchase, Empire will repair or replace at Empire's option.

Limited Two-Year Parts Warranty – Valves

Should the valve fail because of defective workmanship or material within two years from the date of purchase, Empire will repair or replace at Empire's option.

Limited One-Year Parts Warranty – Remote Controls, Accessories, and Parts

Should any remote control, thermostat, accessory, or other part fail because of defective workmanship within one year from the date of purchase, Empire will repair or replace at Empire's option.

Duties of the Owner

The appliance must be installed by a qualified installer and operated in accordance with the instructions furnished with the appliance. A bill of sale, cancelled check, or payment record should be kept to verify purchase date and establish warranty period. Ready access to the appliance for service.

What Is Not Covered

Damages that might result from the use, misuse, or improper installation of this appliance.
Travel, diagnostic costs and freight charges on warranted parts to and from the factory.
Claims that do not involve defective workmanship or materials.
Unauthorized service or parts replacements.
Removal and reinstallation cost.
Inoperable due to improper or lack of maintenance.

How To Get Service

To make a claim under this warranty, please have your receipt available and contact your installing dealer. Provide the dealer with the model number, serial number, type of gas, and purchase verification. The installing dealer is responsible for providing service and will contact the factory to initiate any warranted parts replacements. Empire will make replacement parts available at the factory. Shipping expenses are not covered.

If, after contacting your Empire dealer, service received has not been satisfactory, contact: Consumer Relations Department, Empire Comfort Systems Inc., PO Box 529, Belleville, Illinois 62222, or send an e-mail to info@empirecomfort.com with "Consumer Relations" in the subject line.

Your Rights Under State Law

This warranty gives you specific legal rights, and you may also have other rights, which vary from state to state.

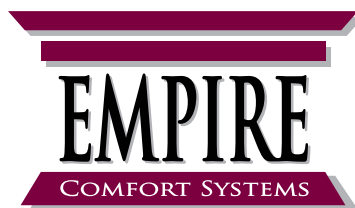

SINCE 1932

www.empirecomfort.com

Empire Comfort Systems Inc.
Belleville, IL

If you have a general question
about our products, please e-mail
us at info@empirecomfort.com.

If you have a service or repair
question, please contact your dealer.